

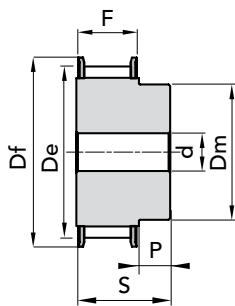
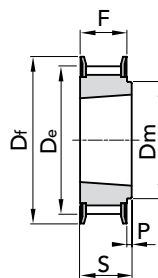
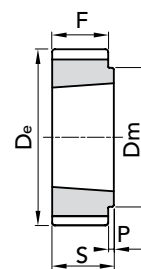

TAPER LOCK® FOSFATATE

TIPO 8M-12

**ESEC. 1F****ESEC. 2F****ESEC. 3**

TIPO	CODICE	N. DENTI	ESEC.	BUSS.	FORO MAX	Dp	De	Df FLANGIA	Dm MOZZO	F	S	P	N. FLANGIA	Peso kg.
8M-22S- 12	48612022	22	1F	-	28	56,02	54,42	60	43	20	30	10	53	0,43
TL 8M-25S- 12	48612025	25	2F	1108	28	63,66	62,06	70	49	20	22	2	61	0,25
TL 8M-28S- 12	48612028	28	2F	1108	28	71,3	69,7	75	56	20	22	2	79	0,37
TL 8M-30S- 12	48612030	30	2F	1210	32	76,39	74,79	82,5	60	20	25	5	82	0,41
TL 8M-32S- 12	48612032	32	2F	1610	42	81,49	79,89	87	66	20	25	5	76	0,43
TL 8M-34S- 12	48612034	34	2F	1610	42	86,58	84,98	91	69	20	25	5	66	0,45
TL 8M-36S- 12	48612036	36	2F	1610	42	91,67	90,07	97	76	20	25	5	68	0,59
TL 8M-38S- 12	48612038	38	2F	1610	42	96,77	95,17	102	78	20	25	5	70	0,70
TL 8M-40S- 12	48612040	40	2F	1610	42	101,86	100,26	106	85	20	25	5	77	0,82
TL 8M-45S- 12	48612045	45	2F	2012	50	114,59	112,99	120	92	20	32	12	75	1,10
TL 8M-48S- 12	48612048	48	2F	2012	50	122,23	120,63	128	103	20	32	12	78	1,42
TL 8M-50S- 12	48612050	50	2F	2012	50	127,32	125,72	135	104	20	32	12	80	1,60
TL 8M-56S- 12	48612056	56	2F	2012	50	142,6	141	150	104	20	32	12	85	2,10
TL 8M-60S- 12	48612060	60	2F	2012	50	152,79	151,19	158	111	20	32	12	86	2,40
TL 8M-64S- 12	48612064	64	2F	2012	50	162,97	161,37	168	111	20	32	12	90	2,70
TL 8M-75S- 12	48612075	75	3	2012	50	190,99	189,39	-	111	20	32	12	-	3,70
TL 8M-80S- 12	48612080	80	3	2012	50	203,72	202,12	-	111	20	32	12	-	4,40
TL 8M-90S- 12	48612090	90	3	2012	50	229,18	227,58	-	111	20	32	12	-	5,50

MATERIALE ACCIAIO
C 45

Disegni CAD disponibili sul sito
www.chiaravalli.com

Quantità, disponibilità e prezzi
con B2B Chiaravalli



Le immagini non sono identificative del prodotto.

PULEGGE DENTATE POLY CHAIN® GT® TIPO 8M-12

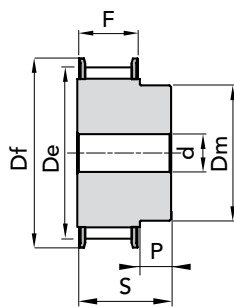
TAPER LOCK® FOSFATATE
TIPO 8M-21

ESEC. 1F

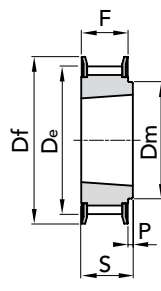

ESEC. 2F

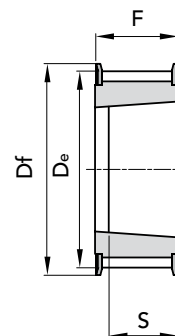

ESEC. 4F

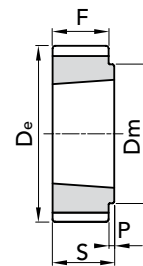

ESEC. 3

TIPO	CODICE	N. DENTI	ESEC.	BUSS.	FORO MAX	Dp	De	Df	Dm	Ø Di	F	S	P	N. FLANGIA	Peso kg.
											FLANGIA MOZZO				
8M-22S- 21	48621022	22	1F	-	28	56,02	54,42	60	43	-	30	40	10	53	0,56
TL 8M-25S- 21	48621025	25	4F	1108	28	63,66	62,06	70	-	-	30	22	-	61	0,36
TL 8M-28S- 21	48621028	28	4F	1210	32	71,3	69,7	75	-	-	30	25	-	79	0,41
TL 8M-30S- 21	48621030	30	4F	1210	32	76,39	74,79	82,5	-	-	30	25	-	82	0,56
TL 8M-32S- 21	48621032	32	4F	1610	42	81,49	79,89	87	-	-	30	25	-	76	0,52
TL 8M-34S- 21	48621034	34	4F	1610	42	86,58	84,98	91	-	-	30	25	-	66	0,61
TL 8M-36S- 21	48621036	36	4F	1610	42	91,67	90,07	97	-	-	30	25	-	68	0,70
TL 8M-38S- 21	48621038	38	4F	1610	42	96,77	95,17	102	-	-	30	25	-	70	0,92
TL 8M-40S- 21	48621040	40	4F	1610	42	101,86	100,26	106	-	-	30	25	-	77	1,06
TL 8M-45S- 21	48621045	45	2F	2012	50	114,59	112,99	120	92	-	30	32	2	75	1,30
TL 8M-48S- 21	48621048	48	2F	2012	50	122,23	120,63	128	103	-	30	32	2	78	1,60
TL 8M-50S- 21	48621050	50	2F	2012	50	127,32	125,72	135	104	-	30	32	2	80	1,83
TL 8M-56S- 21	48621056	56	2F	2012	50	142,6	141	150	104	-	30	32	2	85	2,40
TL 8M-60S- 21	48621060	60	2F	2517	60	152,79	151,19	158	124	-	30	45	15	86	3,20
TL 8M-64S- 21	48621064	64	2F	2517	60	162,97	161,37	168	124	-	30	45	15	90	3,80
TL 8M-75S- 21	48621075	75	3	2517	60	190,99	189,39	-	124	-	30	45	15	-	6,20
TL 8M-80S- 21	48621080	80	3	2517	60	203,72	202,12	-	124	-	30	45	15	-	6,00
TL 8M-90S- 21	48621090	90	11	2517	60	229,18	227,58	-	124	198	30	45	7,5	-	5,40
TL 8M-112S- 21	48621112	112	11	2517	60	285,21	283,61	-	124	253	30	45	7,5	-	7,40
TL 8M-140S- 21	48621140	140	13	3020	75	356,51	354,91	-	150	324	30	51	10,5	-	9,00

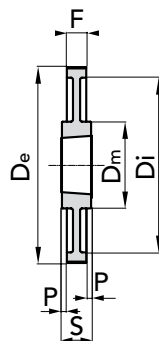

ESEC. 11

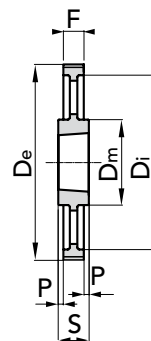

ESEC. 13

 MATERIALE **ACCIAIO**
C 45

 MATERIALE **GHISA**

 Disegni CAD disponibili sul sito
www.chiaravalli.com

 Quantità, disponibilità e prezzi
 con B2B Chiaravalli



TAPER LOCK® FOSFATATE

TIPO 8M-36

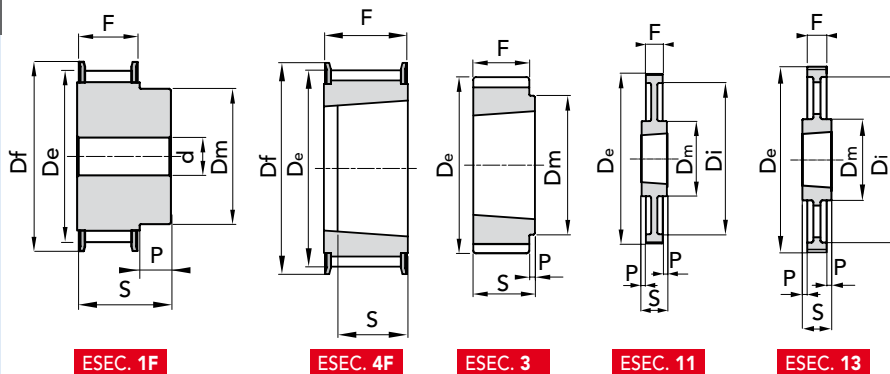

ESEC. 1F

ESEC. 4F

ESEC. 3

ESEC. 11

ESEC. 13

TIPO	CODICE	N. DENTI	ESEC.	BUSS. MAX	FORO MAX	Dp	De	Df	Dm	Ø Di	F	S	P	N. FLANGIA	Peso kg.
8M-25S- 36	48636025	25	1F	-	32	63,66	62,06	70	49	-	45	55	10	61	1,40
TL 8M-28S- 36	48636028	28	4F	1210	32	71,3	69,7	75	-	-	45	25	-	79	0,64
TL 8M-30S- 36	48636030	30	4F	1610	42	76,39	74,79	82,5	-	-	45	25	-	82	0,59
TL 8M-32S- 36	48636032	32	4F	1610	42	81,49	79,89	87	-	-	45	25	-	76	0,79
TL 8M-34S- 36	48636034	34	4F	1610	42	86,58	84,98	91	-	-	45	25	-	66	0,63
TL 8M-36S- 36	48636036	36	4F	1610	42	91,67	90,07	97	-	-	45	25	-	68	1,15
TL 8M-38S- 36	48636038	38	4F	1610	42	96,77	95,17	102	-	-	45	25	-	70	1,39
TL 8M-40S- 36	48636040	40	4F	2012	50	101,86	100,26	106	-	-	45	32	-	77	1,34
TL 8M-45S- 36	48636045	45	4F	2012	50	114,59	112,99	120	-	-	45	32	-	75	1,87
TL 8M-48S- 36	48636048	48	4F	2012	50	122,23	120,63	128	-	-	45	32	-	78	2,20
TL 8M-50S- 36	48636050	50	4F	2012	50	127,32	125,72	135	-	-	45	32	-	80	2,70
TL 8M-56S- 36	48636056	56	4F	2517	60	142,6	141	150	-	-	45	45	-	85	3,00
TL 8M-60S- 36	48636060	60	4F	2517	60	152,79	151,19	158	-	-	45	45	-	86	3,80
TL 8M-64S- 36	48636064	64	4F	2517	60	162,97	161,37	168	-	-	45	45	-	90	4,50
TL 8M-75S- 36	48636075	75	3	3020	75	190,99	189,39	-	150	-	45	51	6	-	6,20
TL 8M-80S- 36	48636080	80	3	3020	75	203,72	202,12	-	150	-	45	51	6	-	7,40
TL 8M-90S- 36	48636090	90	11	3020	75	229,18	227,58	-	150	197	45	51	3	-	7,20
TL 8M-112S- 36	48636112	112	11	3020	75	285,21	283,61	-	150	253	45	51	3	-	10,40
TL 8M-140S- 36	48636140	140	13	3020	75	356,51	354,91	-	150	324	45	51	3	-	12,70
TL 8M-168S- 36	48636168	168	13	3525	100	427,81	426,21	-	198	396	45	65	10	-	21,50
TL 8M-192S- 36	48636192	192	13	3525	100	488,92	487,32	-	198	457	45	65	10	-	27,00

MATERIALE **ACCIAIO**
C 45

MATERIALE **GHISA**

Disegni CAD disponibili sul sito
www.chiaravalli.com

Quantità, disponibilità e prezzi
con B2B Chiaravalli



Le immagini non sono identificative del prodotto.

PULEGGE DENTATE POLY CHAIN® GT® TIPO 8M-36

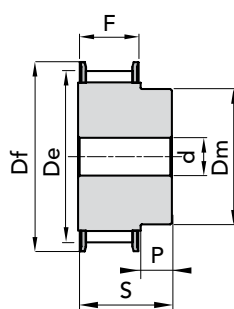
TAPER LOCK® FOSFATATE
TIPO 8M-62

ESEC. 1F

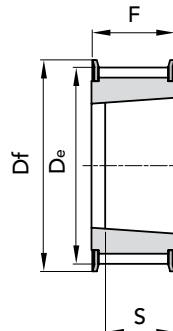

ESEC. 4F

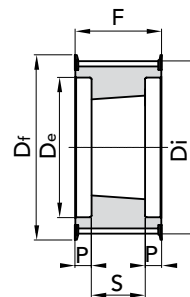

ESEC. 7F

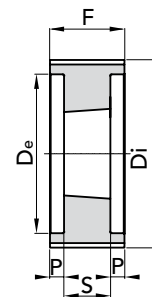

ESEC. 6

TIPO	CODICE	N. DENTI	ESEC.	BUSS.	FORO MAX	Dp	De	Df	Dm	Ø Di	F	S	P	N. FLANGIA	Peso kg.
					FLANGIA MOZZO										
8M-30S- 62	48662030	30	1F	-	42	76,39	74,79	82,5	63	-	72	84	12	82	2,40
8M-32S- 62	48662032	32	1F	-	50	81,49	79,89	87	68	-	72	84	12	76	2,80
8M-34S- 62	48662034	34	1F	-	55	86,58	84,98	91	69	-	72	84	12	66	3,00
8M-36S- 63	48662036	36	1F	-	60	91,67	90,07	97	76	-	72	84	12	68	3,40
8M-38S- 62	48662038	38	1F	-	60	96,77	95,17	102	78	-	72	84	12	70	3,80
TL 8M-40S- 62	48662040	40	4F	2012	50	101,86	100,26	106	-	-	72	32	-	77	2,06
TL 8M-45S- 62	48662045	45	4F	2012	50	114,59	112,99	120	-	-	72	32	-	75	3,00
TL 8M-48S- 62	48662048	48	4F	2517	60	122,23	120,63	128	-	-	72	45	-	78	2,90
TL 8M-50S- 62	48662050	50	4F	2517	60	127,32	125,72	135	-	-	72	45	-	80	3,25
TL 8M-56S- 62	48662056	56	7F	2517	60	142,6	141	150	-	111	72	45	13,5	85	3,90
TL 8M-60S- 62	48662060	60	7F	2517	60	152,79	151,19	158	-	121	72	45	13,5	86	4,70
TL 8M-64S- 62	48662064	64	7F	2517	60	162,97	161,37	168	-	131	72	45	13,5	90	5,60
TL 8M-75S- 62	48662075	75	6	3020	75	190,99	189,39	-	-	159	72	51	10,5	-	7,50
TL 8M-80S- 62	48662080	80	6	3020	75	203,72	202,12	-	-	172	72	51	10,5	-	9,20
TL 8M-90S- 62	48662090	90	6	3020	75	229,18	227,58	-	-	197	72	51	10,5	-	7,70
TL 8M-112S- 62	48662112	112	8	3020	75	285,21	283,61	-	198	253	72	51	10,5	-	12,10
TL 8M-140S- 62	48662140	140	10	3525	100	356,51	354,91	-	150	324	72	65	3,5	-	22,70
TL 8M-168S- 62	48662168	168	10	3525	100	427,81	426,21	-	198	396	72	65	3,5	-	26,80
TL 8M-192S- 62	48662192	192	10	3525	100	488,92	487,32	-	198	457	72	65	3,5	-	34,20

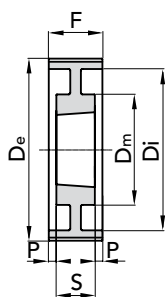

ESEC. 8

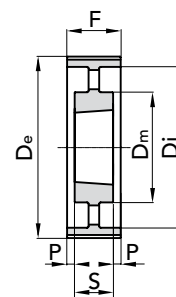

ESEC. 10

 MATERIALE **ACCIAIO**
C 45

 MATERIALE **GHISA**

 Disegni CAD disponibili sul sito
www.chiaravalli.com

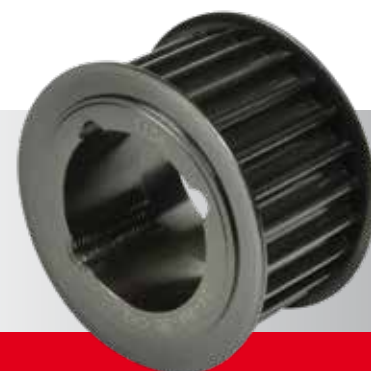
 Quantità, disponibilità e prezzi
 con B2B Chiaravalli



TAPER LOCK® FOSFATATE

TIPO 14M-20

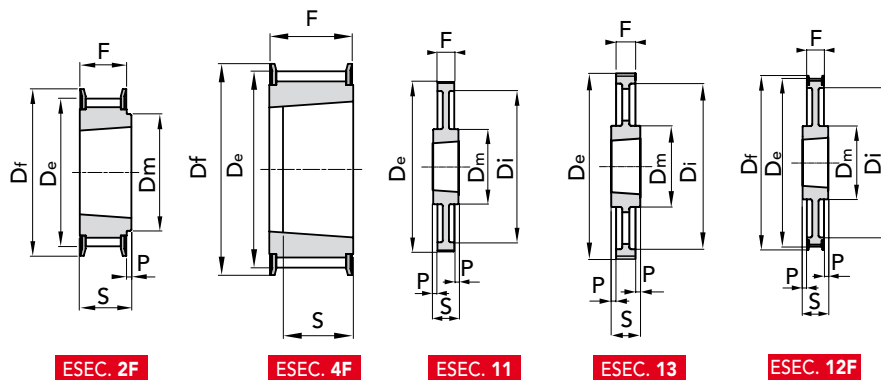

TIPO	CODICE	N. DENTI	ESEC.	BUSS. MAX	FORO MAX	Dp	De	Df FLANGIA	Dm MOZZO	Ø Di	F	S	P	N. FLANGIA	Peso kg.
TL 14M-28S-20	48820028	28	4F	2012	50	124,78	121,98	128	-	-	33	32	1	153	1,66
TL 14M-30S-20	48820030	30	4F	2012	50	133,69	130,89	138	-	-	33	32	1	154	2,20
TL 14M-32S-20	48820032	32	4F	2012	50	142,6	139,8	154	-	-	33	32	1	160	3,20
TL 14M-34S-20	48820034	34	2F	2517	60	151,52	148,72	160	117	-	33	45	-	171	3,00
TL 14M-36S-20	48820036	36	2F	2517	60	160,43	157,63	168	117	-	33	45	-	168	3,60
TL 14M-38S-20	48820038	38	2F	2517	60	169,34	166,54	183	117	-	33	45	-	172	4,00
TL 14M-40S-20	48820040	40	2F	2517	60	178,25	175,45	188	117	-	33	45	-	174	4,70
TL 14M-44S-20	48820044	44	2F	3020	75	196,08	193,28	211	144	-	33	51	-	175	5,60
TL 14M-48S-20	48820048	48	2F	3020	75	213,9	211,11	226	144	-	33	51	-	180	6,80
TL 14M-50S-20	48820050	50	2F	3020	75	222,82	220,02	240	144	-	33	51	-	169	7,70
TL 14M-56S-20	48820056	56	12F	3020	75	249,55	246,76	256	144	207	33	51	9	182	7,70
TL 14M-60S-20	48820060	60	11	3020	75	267,38	264,58	-	159	224	33	51	9	-	8,50
TL 14M-64S-20	48820064	64	11	3020	75	285,21	282,41	-	159	242	33	51	9	-	10,20
TL 14M-72S-20	48820072	72	11	3020	75	320,86	318,06	-	159	278	33	51	9	-	11,50
TL 14M-80S-20	48820080	80	11	3020	75	356,51	353,71	-	159	314	33	51	9	-	13,50
TL 14M-90S-20	48820090	90	13	3020	75	401,07	398,27	-	159	360	33	51	9	-	14,20
TL 14M-112S-20	48820112	112	13	3020	75	499,11	496,31	-	159	456	33	51	9	-	18,10
TL 14M-140S-20	48820140	140	13	3020	75	623,89	621,09	-	159	581	33	51	9	-	22,90

MATERIALE ACCIAIO
C 45

MATERIALE GHISA

Disegni CAD disponibili sul sito
www.chiaravalli.com

Quantità, disponibilità e prezzi
con B2B Chiaravalli



Le immagini non sono identificative del prodotto.

PULEGGE DENTATE POLY CHAIN® GT® TIPO 14M-20

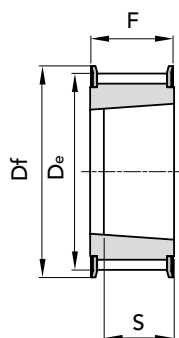
TAPER LOCK® FOSFATATE
TIPO 14M-37

ESEC. 4F

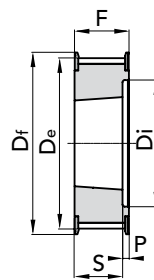

ESEC. 5F

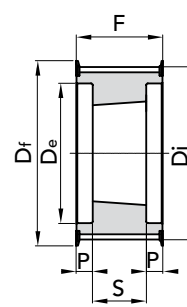

ESEC. 7F

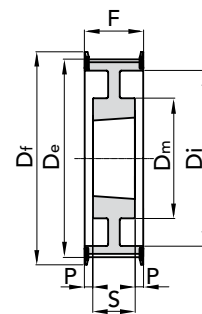

ESEC. 9F

TIPO	CODICE	N. DENTI	ESEC.	BUSS.	FORO MAX	Dp	De	Df	Dm	Ø Di	F	S	P	N. FLANGIA	Peso kg.
TL 14M-28S-37	48837028	28	5F	2012	50	124,78	121,98	128	-	88	51	32	19	153	2,20
TL 14M-30S-37	48837030	30	7F	2517	60	133,69	130,89	138	-	98	51	45	3	154	2,50
TL 14M-32S-37	48837032	32	7F	2517	60	142,6	139,8	154	-	100	51	45	3	160	3,00
TL 14M-34S-37	48837034	34	7F	2517	60	151,52	148,72	160	-	109	51	45	3	171	3,80
TL 14M-36S-37	48837036	36	5F	2517	60	160,43	157,63	168	-	117	51	45	6	168	4,30
TL 14M-38S-37	48837038	38	5F	2517	60	169,34	166,54	183	-	126	51	45	6	172	5,10
TL 14M-40S-37	48837040	40	5F	2517	60	178,25	175,45	188	-	135	51	45	6	174	6,00
TL 14M-44S-37	48837044	44	4F	3020	75	196,08	193,82	211	-	-	51	51	-	175	7,00
TL 14M-48S-37	48837048	48	4F	3020	75	213,9	211,11	226	-	-	51	51	-	180	9,00
TL 14M-50S-37	48837050	50	4F	3020	75	222,82	220,02	240	-	-	51	51	-	169	10,00
TL 14M-56S-37	48837056	56	9F	3020	75	249,55	246,76	256	144	207	51	51	-	182	9,20
TL 14M-60S-37	48837060	60	8	3020	75	267,38	264,58	-	159	224	51	51	-	-	10,20
TL 14M-64S-37	48837064	64	8	3020	75	285,21	282,41	-	159	242	51	51	-	-	12,20
TL 14M-72S-37	48837072	72	8	3020	75	320,86	318,06	-	159	278	51	51	-	-	13,40
TL 14M-80S-37	48837080	80	8	3020	75	356,51	353,71	-	159	314	51	51	-	-	16,10
TL 14M-90S-37	48837090	90	10	3020	75	401,07	398,27	-	159	360	51	51	-	-	17,20
TL 14M-112S-37	48837112	112	10	3020	75	499,11	496,31	-	159	456	51	51	-	-	23,00
TL 14M-140S-37	48837140	140	13	3525	100	623,89	621,09	-	206	581	51	65	7	-	41,00
TL 14M-168S-37	48837168	168	13	3525	100	748,66	745,87	-	206	706	51	65	7	-	51,50
TL 14M-192S-37	48837192	192	13	4030	115	855,61	852,82	-	215	812	51	76	12,5	-	60,00

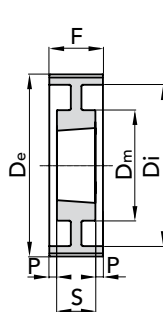

ESEC. 8

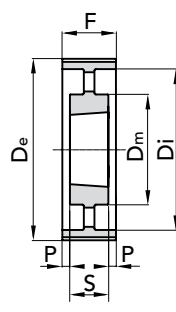

ESEC. 10

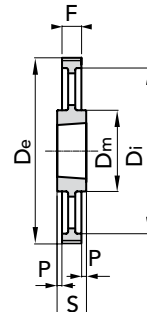

ESEC. 13

 MATERIALE ACCIAIO
C 45

MATERIALE GHISA

 Disegni CAD disponibili sul sito
www.chiaravalli.com

 Quantità, disponibilità e prezzi
con B2B Chiaravalli



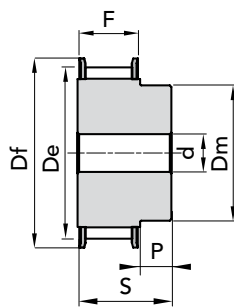
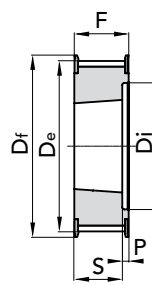
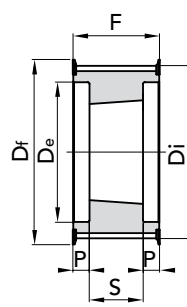
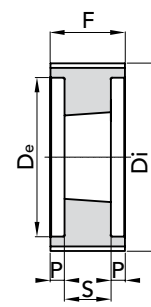

TAPER LOCK® FOSFATATE

TIPO 14M-68

**ESEC. 1F****ESEC. 5F****ESEC. 7F****ESEC. 6**

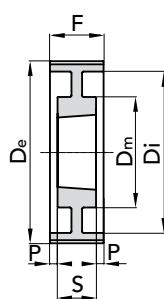
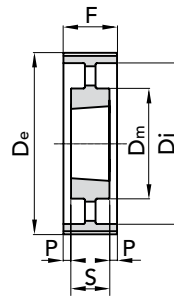
TIPO	CODICE	N. DENTI	ESEC.	BUSS.	FORO MAX	Dp	De	Df	Dm	Ø Di	F	S	P	N. FLANGIA	Peso kg.
14M-34S- 68	48868034	34	1F	-	100	151,52	148,72	160	132	-	84	104	20	171	10,50
14M-36S- 68	48868036	36	1F	-	100	160,43	157,63	168	131	-	84	104	20	168	11,70
14M-38S- 68	48868038	38	1F	-	115	169,34	166,54	183	141	-	84	104	20	172	13,40
14M-40S- 68	48868040	40	1F	-	125	178,25	175,45	188	156	-	84	104	20	174	15,40
TL 14M-44S- 68	48868044	44	7F	3020	75	196,08	193,28	211	-	153	84	51	16,5	175	9,20
TL 14M-48S- 68	48868048	48	5F	3020	75	213,9	211,11	226	-	171	84	51	33	180	11,30
TL 14M-50S- 68	48868050	50	7F	3525	100	222,82	220,02	240	-	180	84	65	9,5	169	15,50
TL 14M-56S- 68	48868056	56	7F	3525	100	249,55	246,76	256	-	207	84	65	9,5	182	16,80
TL 14M-60S- 68	48868060	60	6	3525	100	267,38	264,58	-	-	224	84	65	9,5	-	20,40
TL 14M-64S- 68	48868064	64	6	3525	100	285,21	282,41	-	-	242	84	65	9,5	-	23,60
TL 14M-72S- 68	48868072	72	8	3525	100	320,86	318,06	-	178	278	84	65	9,5	-	20,30
TL 14M-80S- 68	48868080	80	10	3525	100	356,51	353,71	-	178	314	84	65	9,5	-	21,30
TL 14M-90S- 68	48868090	90	10	3525	100	401,07	398,27	-	178	360	84	65	9,5	-	24,40
TL 14M-112S- 68	48868112	112	10	3525	100	499,11	496,31	-	178	456	84	65	9,5	-	32,70
TL 14M-140S- 68	48868140	140	10	3525	100	623,89	621,09	-	206	581	84	65	9,5	-	55,00
TL 14M-168S- 68	48868168	168	10	3525	100	748,66	745,87	-	206	706	84	65	9,5	-	71,00
TL 14M-192S- 68	48868192	192	10	4030	115	855,61	852,82	-	215	812	84	76	4	-	80,50

**ESEC. 8****ESEC. 10**

MATERIALE **ACCIAIO**
C 45

MATERIALE **GHISA**

Disegni CAD disponibili sul sito
www.chiaravalli.com

Quantità, disponibilità e prezzi
con B2B Chiaravalli

Le immagini non sono identificative del prodotto.

PULEGGE DENTATE POLY CHAIN® GT® TIPO 14M-68



TAPER LOCK® FOSFATATE

TIPO 14M-90

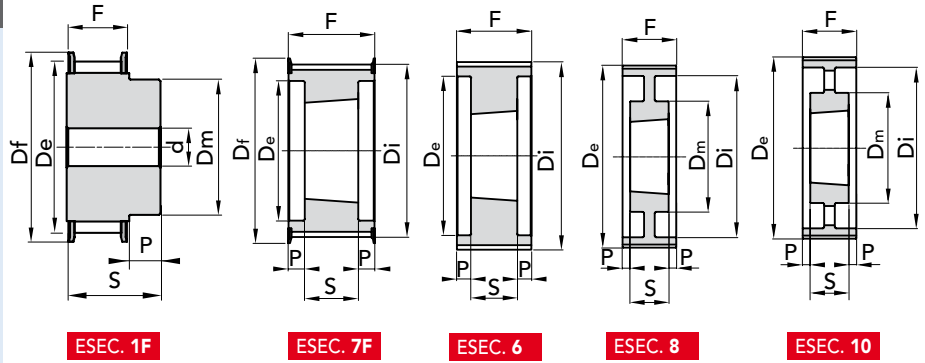

TIPO	CODICE	N. DENTI	ESEC.	BUSS. MAX	FORO	Dp	De	Df	Dm	Ø Di	F	S	P	N. FLANGIA	Peso kg.
14M-36S-90	48890036	36	1F	-	110	160,43	157,63	168	131	-	106	136	30	168	14,50
14M-38S-90	48890038	38	1F	-	115	169,34	166,54	183	141	-	106	136	30	172	17,50
14M-40S-90	48890040	40	1F	-	125	178,25	175,45	188	156	-	106	136	30	174	19,10
14M-44S-90	48890044	44	1F	-	140	196,08	193,82	211	169	-	106	136	30	175	23,90
TL 14M-48S-90	48890048	48	7F	3525	100	213,9	211,11	226	-	171	106	66	20	180	12,70
TL 14M-50S-90	48890050	50	7F	3525	100	222,82	220,02	240	-	180	106	66	20	169	14,50
TL 14M-56S-90	48890056	56	7F	3525	100	249,55	246,76	256	-	207	106	66	20	182	19,00
TL 14M-60S-90	48890060	60	6	3525	100	267,38	264,58	-	-	224	106	66	20	-	22,50
TL 14M-64S-90	48890064	64	6	3525	100	285,21	282,41	-	-	242	106	66	20	-	24,00
TL 14M-72S-90	48890072	72	8	3525	100	320,86	318,06	-	178	278	106	66	20	-	22,60
TL 14M-80S-90	48890080	80	8	4030	115	356,51	353,71	-	215	314	106	76	15	-	27,00
TL 14M-90S-90	48890090	90	8	4030	115	401,07	398,27	-	215	360	106	76	15	-	34,10
TL 14M-112S-90	48890112	112	10	4535	125	499,11	496,31	-	215	456	106	90	8	-	46,00
TL 14M-140S-90	48890140	140	10	4535	125	623,89	621,09	-	215	581	106	90	8	-	61,00
TL 14M-168S-90	48890168	168	10	5040	130	748,66	745,87	-	267	706	106	102	2	-	90,00
TL 14M-192S-90	48890192	192	10	5040	130	855,61	852,82	-	267	812	106	102	2	-	108,50

 MATERIALE ACCIAIO
C 45

MATERIALE GHISA

 Disegni CAD disponibili sul sito
www.chiaravalli.com

 Quantità, disponibilità e prezzi
con B2B Chiaravalli



TAPER LOCK® FOSFATATE

TIPO 14M-125

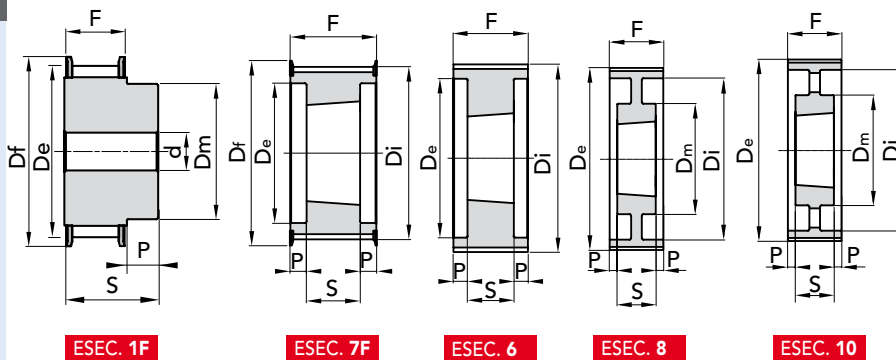

TIPO	CODICE	N. DENTI	ESEC.	BUSS. MAX	FORO MAX	Dp	De	Df	Dm	Ø Di	F	S	P	N. FLANGIA	Peso kg.
14M-38S-125	48892038	38	1F	-	115	169,34	166,54	183	141	-	141	161	20	172	20,30
14M-40S-125	48892040	40	1F	-	125	178,25	175,45	188	156	-	141	161	20	174	23,00
14M-44S-125	48892044	44	1F	-	140	196,08	193,82	211	169	-	141	161	20	175	28,80
14M-48S-125	48892048	48	1F	-	160	213,9	211,11	226	185	-	141	161	20	180	34,60
TL 14M-50S-125	48892050	50	7F	3525	100	222,82	220,02	240	-	180	141	65	38	169	16,80
TL 14M-56S-125	48892056	56	7F	3525	100	249,55	246,76	256	-	207	141	65	38	182	21,60
TL 14M-60S-125	48892060	60	6	4030	115	267,38	264,58	-	-	224	141	76	32,5	-	25,60
TL 14M-64S-125	48892064	64	6	4030	115	285,21	282,41	-	-	242	141	76	32,5	-	29,70
TL 14M-72S-125	48892072	72	8	4030	115	320,86	318,06	-	215	278	141	76	32,5	-	30,00
TL 14M-80S-125	48892080	80	8	4030	125	356,51	353,71	-	215	314	141	76	32,5	-	33,40
TL 14M-90S-125	48892090	90	8	4030	115	401,07	398,27	-	215	360	141	76	32,5	-	39,40
TL 14M-112S-125	48892112	112	10	4535	125	499,11	496,31	-	215	456	141	89	26	-	56,00
TL 14M-140S-125	48892140	140	10	4535	125	623,89	621,09	-	215	581	141	89	26	-	73,00
TL 14M-168S-125	48892168	168	10	5040	125	748,66	745,87	-	267	706	141	102	19,5	-	101,00
TL 14M-192S-125	48892192	192	10	5040	125	855,61	852,82	-	267	802	141	102	19,5	-	121,50

MATERIALE **GHISA**

Disegni CAD disponibili sul sito
www.chiaravalli.com

Quantità, disponibilità e prezzi
con B2B Chiaravalli

